

PLAN D'IMPLANTATION FUTURA 15WCI

VUE DE DESSOUS

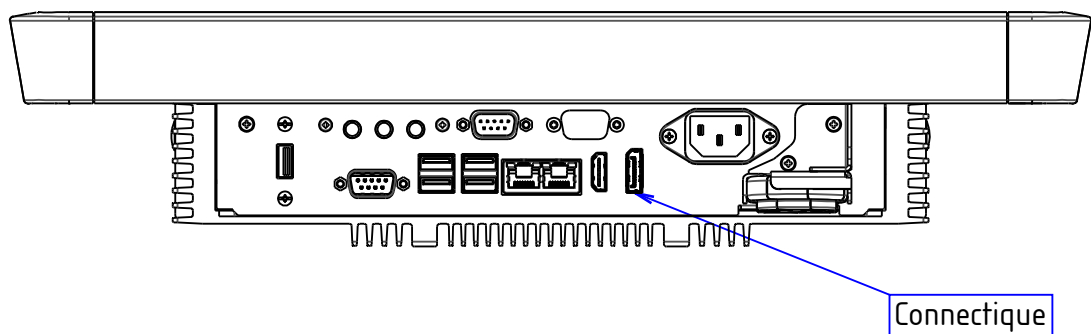

PERSPECTIVE

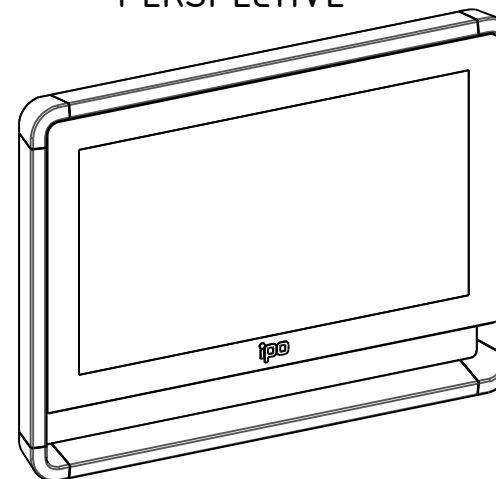

VUE DE FACE

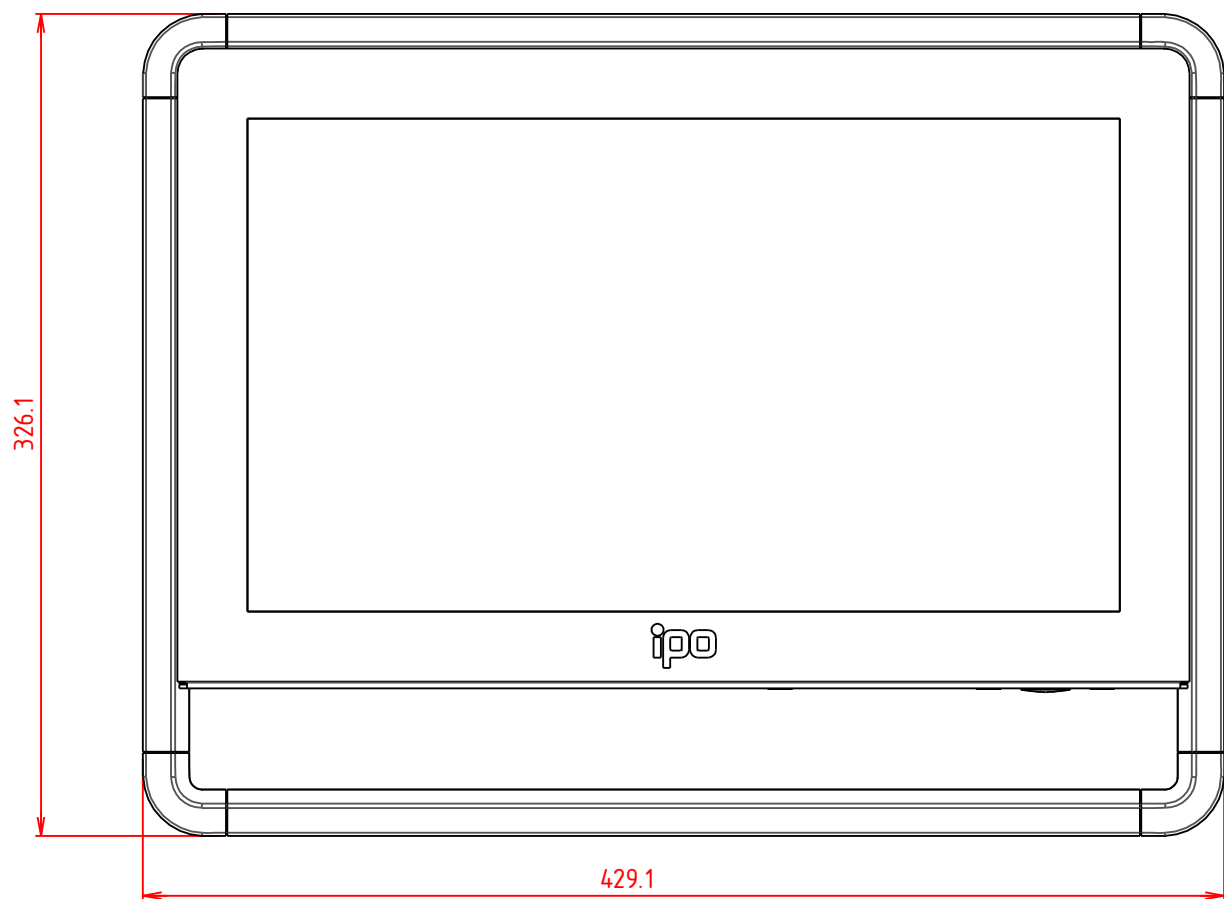

VUE ARRIERE

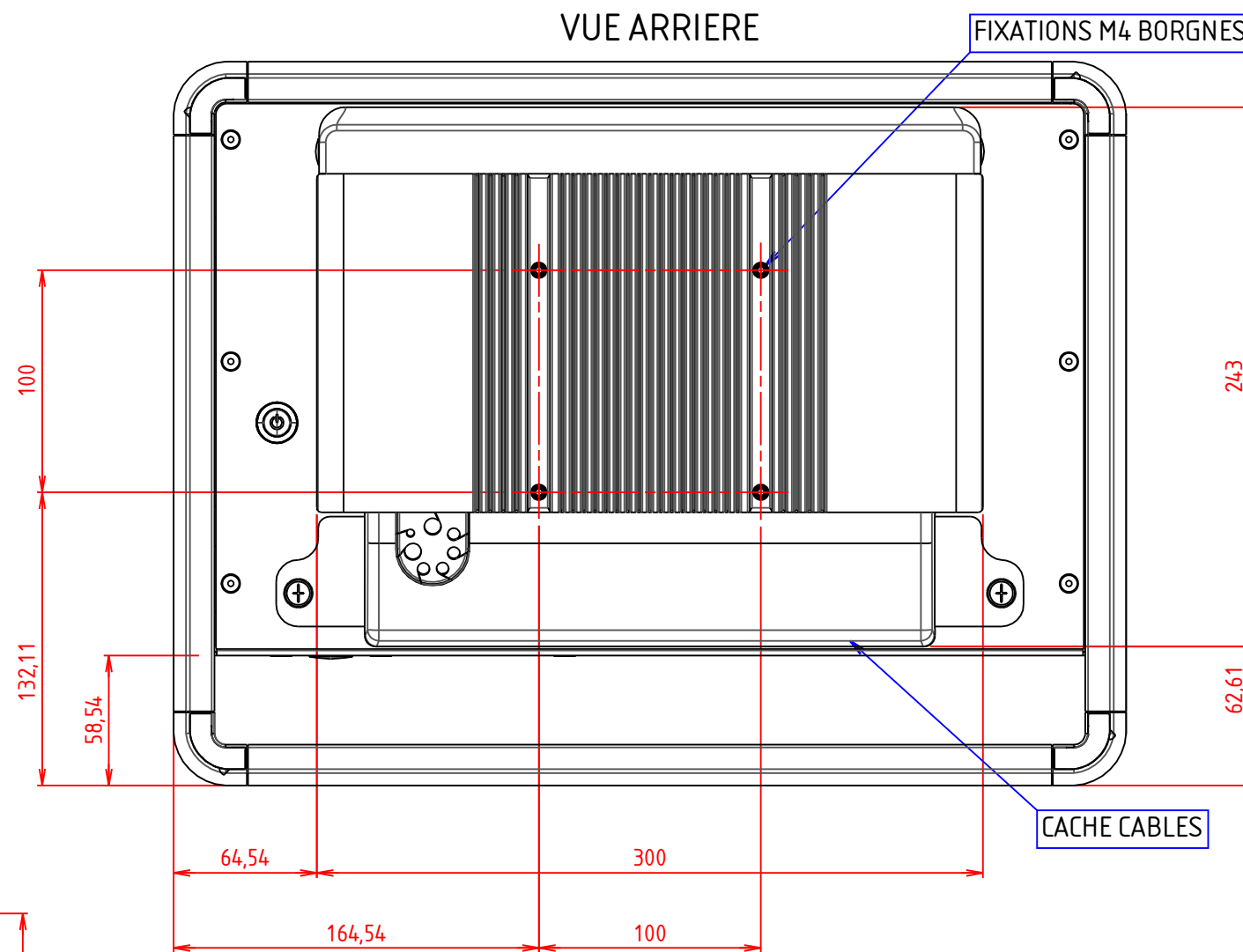

VUE DE DESSUS

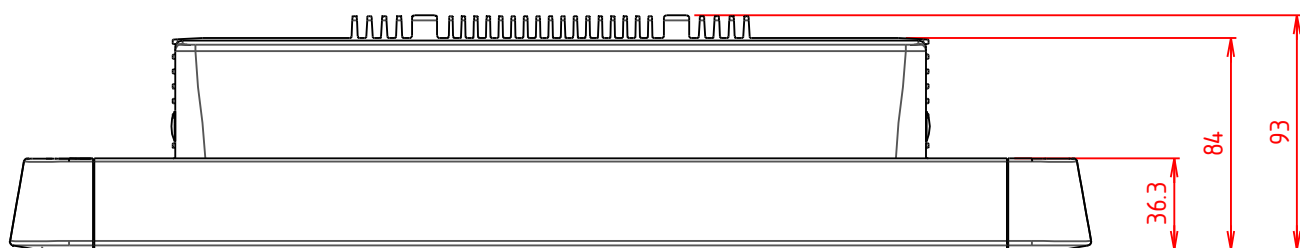

D

A