

PLAN D'IMPLANTATION FUTURA 19WFCI

VUE DE DESSOUS

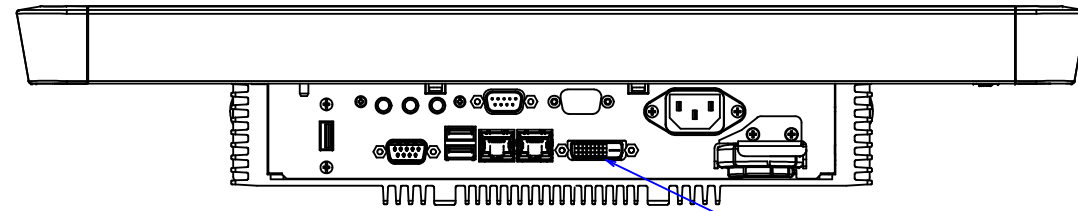

Connectique

PERSPECTIVE

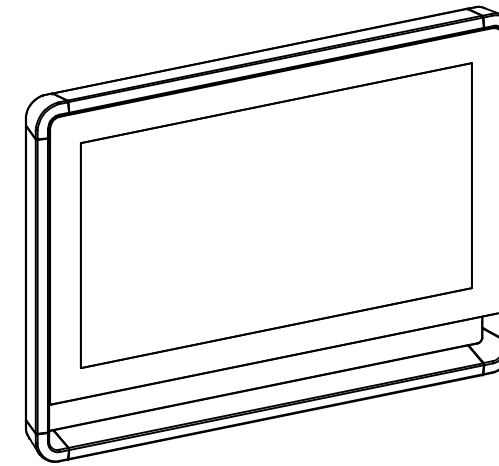

VUE DE FACE

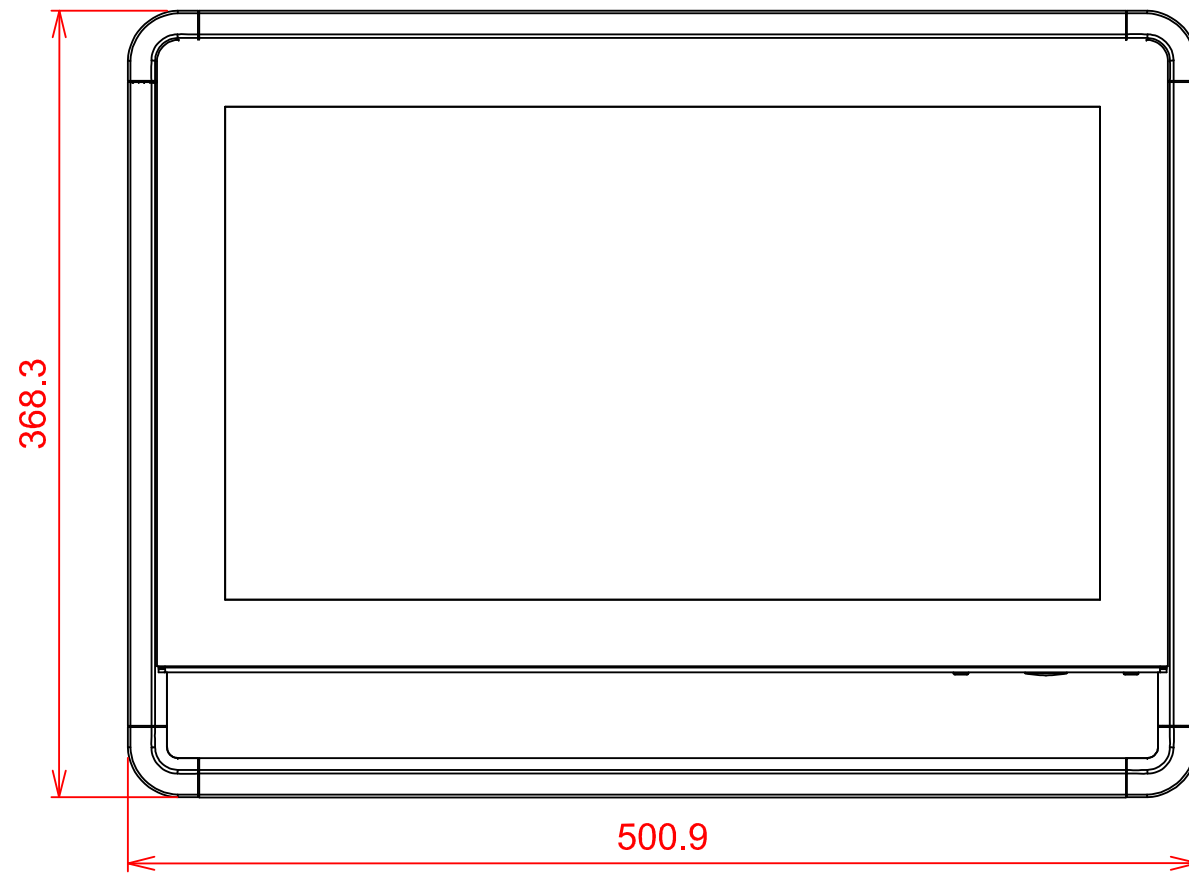

VUE ARRIERE

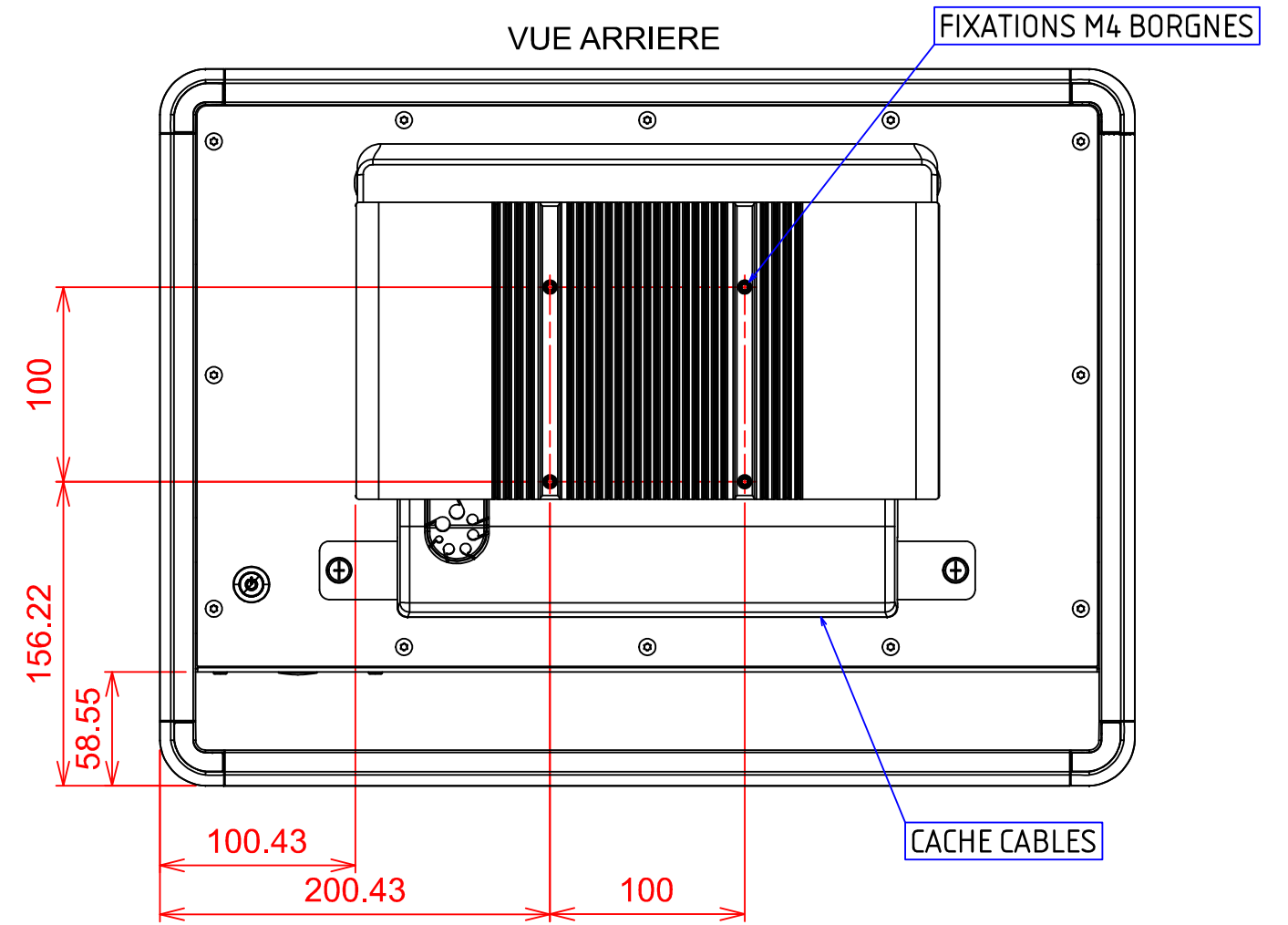

VUE DE DESSUS

